

AIRFOIL

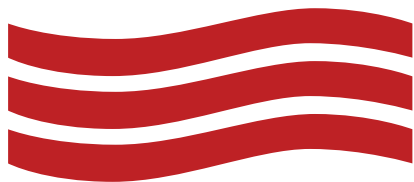

GRILLES
DUCT
FITTINGS

making it happen sooner...



Quality
Endorsed
Company
ISO 9001
 SAI GLOBAL

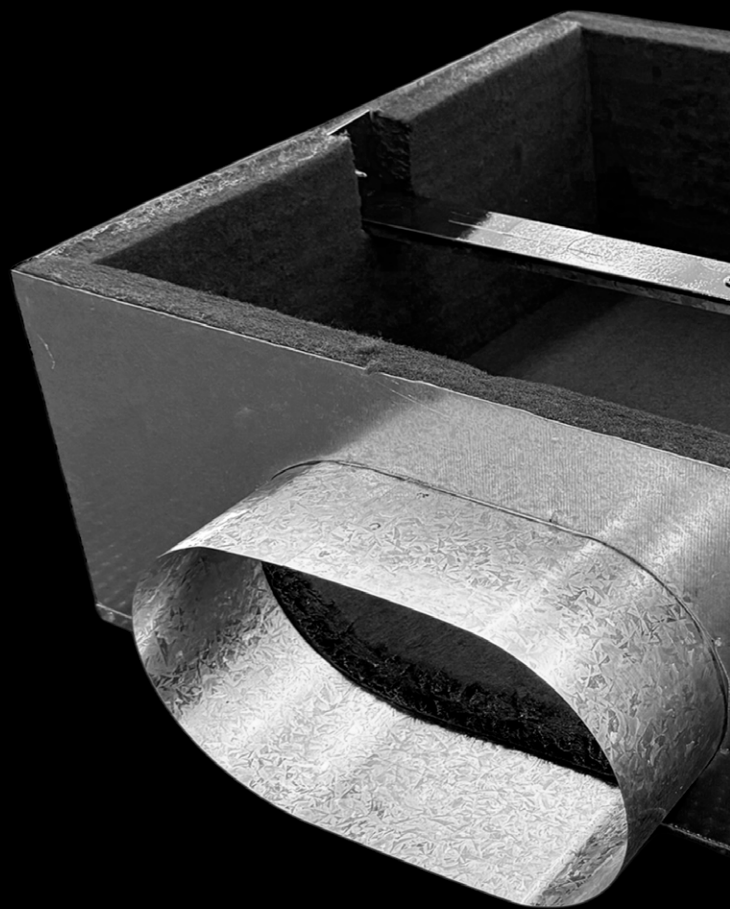

**METAL SWIRL
CUSHION BOX
SWCB-485-485**



METAL SWIRL CUSHION BOX SWCB-485-485

PRODUCT DESCRIPTION AND APPLICATION

Airfoil's premium Australian Made Metal Swirl Cushion Box (SWCB) is specifically crafted to complement our range of high-quality Swirl Diffusers. Featuring an internal "T" brace for added reinforcement, the Swirl Cushion Box is supplied with a root nut that matches the centre swirl screw, ensuring hassle-free installation. Customisable to meet any desired specification, the Swirl Cushion Box caters to special height requirements and challenging spigot placements.

The SWCB-485-485 variant is tailored to fit Airfoil's Swirl Diffuser **CDS-DM350-495F**, with overall dimensions of 485mm x 485mm. This design enables the box to neatly align behind the Swirl Diffuser during installation. Available in heights of 250mm or 300mm, this highly versatile Cushion Box facilitates horizontal supply air delivery directly to the swirl diffuser, resulting in an exceptionally efficient output.

Available in a range of options, the Swirl Cushion Box can be tailored to suit specific needs. Whether opting for an uninsulated (Plain) version or selecting from a variety of standard insulation types such as 5mm or 10mm Rubber, 13mm or 25mm Polyester, or 13mm or 25mm Black-faced Fibreglass and 25mm Perforated Black-faced Fibreglass, Airfoil provides flexibility to meet diverse requirements. Additionally, custom insulation options are available upon request to cater to unique specifications. Furthermore, the box is available with various spigot placements including Side, Opposite, and Adjacent, catering to different duct configuration layouts with ease.

Designed to seamlessly integrate with Airfoil's Swirl Diffusers (CDS), this quality Swirl Cushion Box ensures compatibility and efficiency. Suitable for any commercial setting where thermal and acoustic requirements are paramount, it stands as a testament to Airfoil's commitment to excellence in Sheet Metal solutions.

METAL SWIRL CUSHION BOX SWCB-485-485

PRODUCT SPECIFICATIONS AND INFORMATION

- **Product ordering code – SWCB-485-485**
- Australian Made and Designed
- Manufactured from 0.55mm Australian galvanised steel
- 485mm x 485mm overall size
- Box depth options of 250mm or 300mm
- Designed for Swirl Diffuser **CDS-DM350-495F**
- Custom box heights manufactured to suit grille requirements
- Comes complete with internal “T” Brace
- Comes complete with centre swirl screw for easy installation
- Used for supply air heating and cooling
- Mounted behind grille
- Thermal and Acoustic qualities
- Available in Plain, Rubber (5mm/10mm), Polyester (13mm/25mm), Black-faced Fibreglass (13mm/25mm) or Perforated Black-faced Fibreglass (25mm)
- Spigot sizes available are 100mm, 150mm, 200mm, 250mm, 300mm, 350mm, 400mm, 450mm, 500mm, 550mm and 600mm diameters
- Customised oval spigots available to suit varying box height restrictions
- Suitable for any commercial setting
- Airfoil information available
- **Full product tested information is available upon request. All tested information performed by Airfoil through the laboratories of Vipac Engineers & Scientists.**



METAL SWIRL CUSHION BOX SWCB-485-485

CROSS SECTIONAL DIAGRAM

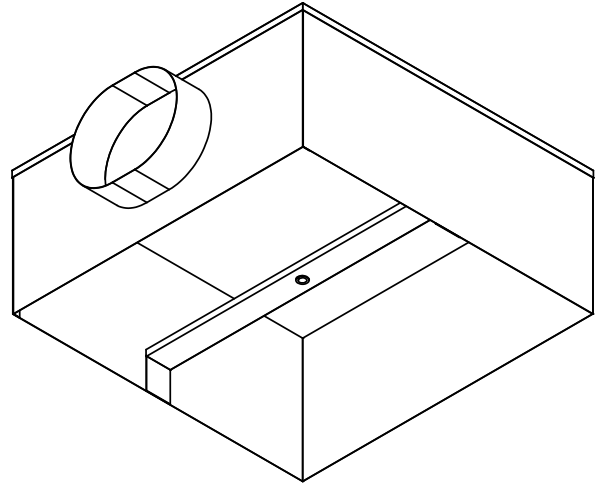
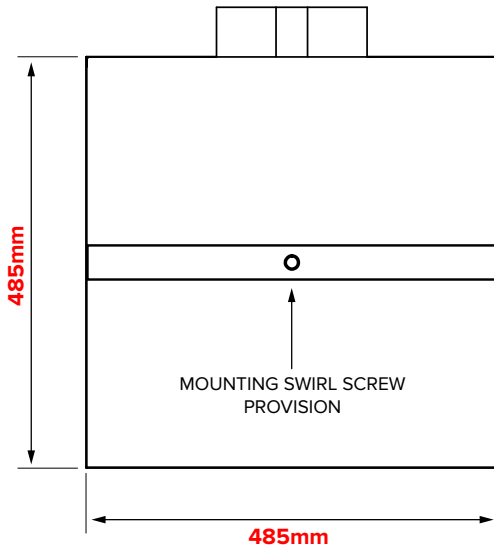

SWCB - 485-485

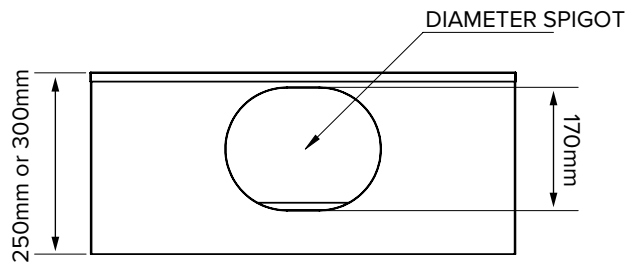

SIDE PROFILES - SWCB - 485-485

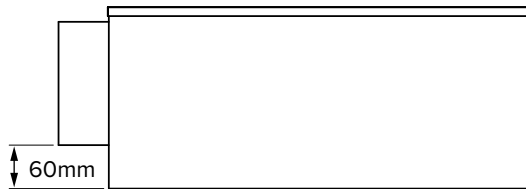

DISCLAIMER:

All product designs, data sheets and specifications presented herein are the intellectual property of Airfoil Manufacturing Pty Ltd. These designs and specifications, including but not limited to diagrams, drawings, and performance data, are protected under Australian intellectual property laws. No part of these designs and specifications may be copied, reproduced, distributed, or transmitted in any form or by any means without the prior written permission of Airfoil Manufacturing Pty Ltd. Unauthorised use or reproduction of these materials may result in legal action under Australian copyright and intellectual property laws.