

# AIRFOIL

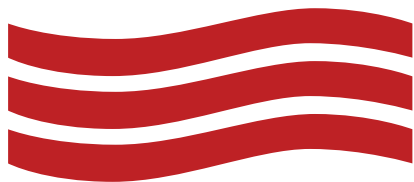

GRILLES  
DUCT  
FITTINGS

*making it happen sooner...*



Quality  
Endorsed  
Company  
ISO 9001  
 SAI GLOBAL

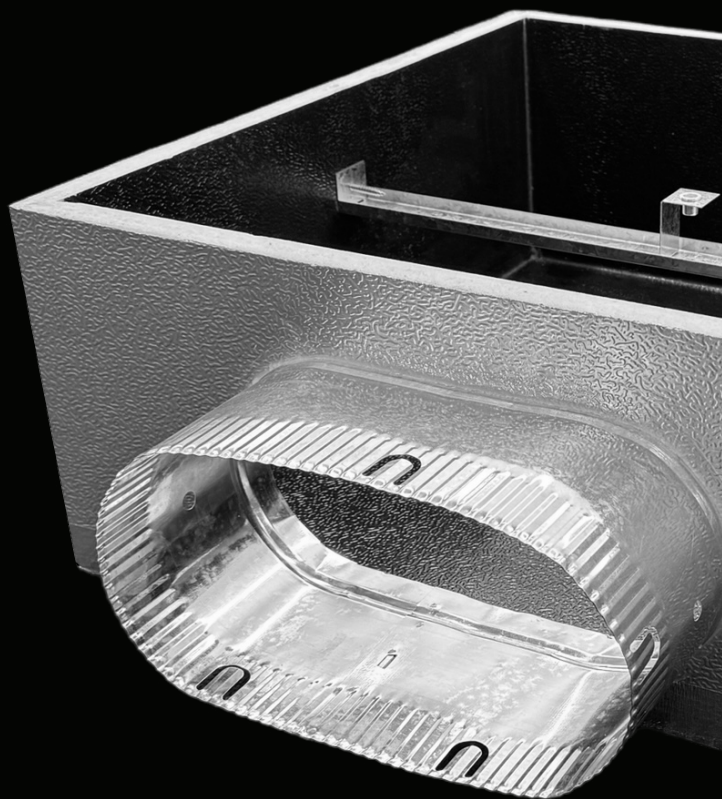

**POLY BOARD SWIRL  
CUSHION BOX  
PSW-CB-485-485**



## **POLY BOARD SWIRL CUSHION BOX** **PSW-CB-485-485**

### **PRODUCT DESCRIPTION AND APPLICATION**

Airfoil's Australian Made 20mm Polyurethane Foam Pre-Insulated Poly Board Swirl Cushion Box (PSW-CB) is a light weight Fire Rated alternative to our Sheet Metal range. The Poly Board aluminium sheeted exterior is coated with a 2g/m<sup>2</sup> resistant epoxy varnish further enhancing its insulation qualities guaranteeing durability and reliability.

Featuring an internal "T" brace for added reinforcement, the Swirl Cushion Box is supplied with a root nut that matches the centre swirl screw, ensuring hassle-free installation. Customisable to meet any desired specification, the Swirl Cushion Box caters to special height requirements and challenging spigot placements.

The PSW-CB-485-485 variant is tailored to fit Airfoil's Swirl Diffuser **CDS-DM350-495F** with overall dimensions of 485mm x 485mm. This design enables the box to neatly align behind the Swirl Diffuser during installation. Available in heights of 250mm or 300mm, this highly versatile Swirl Cushion Box facilitates horizontal supply air delivery directly to the swirl diffuser, resulting in an exceptionally efficient output. Furthermore, the box is available with various spigot placements including Side, Opposite, and Adjacent, catering to different duct configuration layouts with ease.

Designed to seamlessly integrate with Airfoil's Swirl Diffusers (CDS), this quality Swirl Cushion Box ensures compatibility and efficiency. Suitable for any commercial setting where thermal and acoustic requirements are paramount, it stands as a testament to Airfoil's commitment to excellence in Poly Board solutions.

## POLY BOARD SWIRL CUSHION BOX PSW-CB-485-485

### PRODUCT SPECIFICATIONS AND INFORMATION

- **Product ordering code – PSW-CB-485-485**
- Australian Made and Designed
- Manufactured from light weight 20mm Polyurethane Foam (Pre-Insulated)
- 485mm x 485mm overall size
- Box depth options of 250mm or 300mm
- Designed for Swirl Diffuser **CDS-DM350-495F**
- Aluminium Outside / Black-Faced internal
- Comes complete with internal “T” Brace
- Comes complete with centre swirl screw for easy installation
- R-Value
- Coated with 2g/m<sup>2</sup> resistant epoxy varnish
- Density = 66kg/m<sup>3</sup>
- Available with optional 20mm C-Extrusions cover attachment trim
- Easy installation
- Custom box heights manufactured to suit grille requirements
- Mounted behind grille
- Thermal and Acoustic qualities
- Variety of spigot placements available (Side, Opposite & Adjacent)
- Spigot sizes available are 100mm, 150mm, 200mm, 250mm, 300mm, 350mm, 400mm, 450mm, 500mm, 550mm and 600mm diameters
- Customised oval spigots available to suit varying box height restrictions
- Used for supply air diffusion for heating and cooling
- **Full product tested information is available upon request. All tested information performed by Airfoil through the laboratories of Vipac Engineers & Scientists.**



## POLY BOARD SWIRL CUSHION BOX PSW-CB-485-485

### CROSS SECTIONAL DIAGRAM

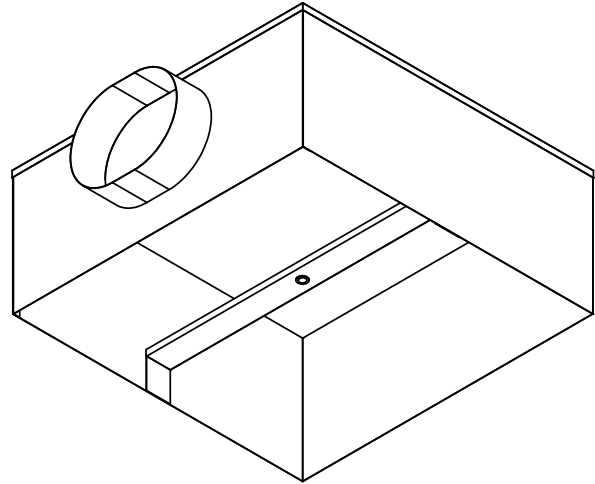
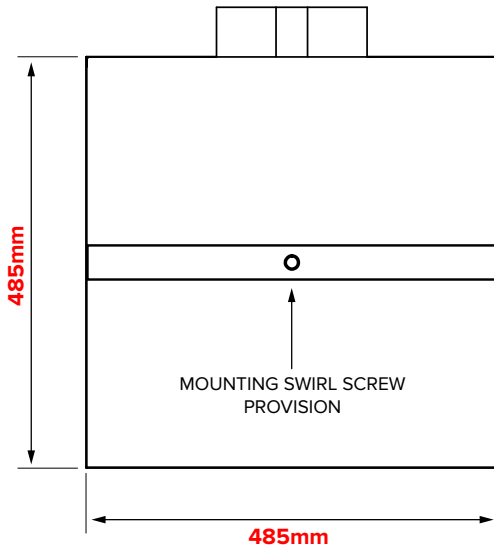

PSW-CB - 485-485

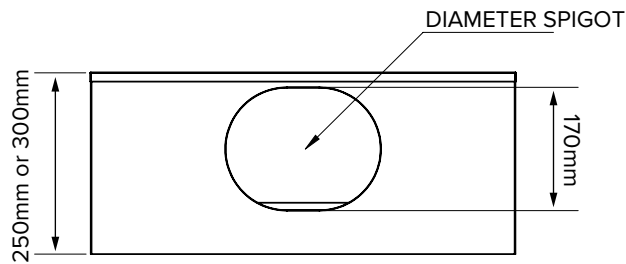

SIDE PROFILES - PSW-CB - 485-485



#### DISCLAIMER:

All product designs, data sheets and specifications presented herein are the intellectual property of Airfoil Manufacturing Pty Ltd. These designs and specifications, including but not limited to diagrams, drawings, and performance data, are protected under Australian intellectual property laws. No part of these designs and specifications may be copied, reproduced, distributed, or transmitted in any form or by any means without the prior written permission of Airfoil Manufacturing Pty Ltd. Unauthorised use or reproduction of these materials may result in legal action under Australian copyright and intellectual property laws.

## POLY BOARD SWIRL CUSHION BOX PSW-CB-485-485

### PU FOAM PRE-INSULATED PANEL (20MM THICK)

Polyurethane Foam Pre-insulated Panels consists of 20 mm thickness with aluminium foil, aluminium sheet or Galvanised Iron on both or either sides. The aluminium foil is coated with a 2g/m<sup>2</sup> layer of corrosion-resistant epoxy varnish paint which also acts to reduce fungus and mold growth.

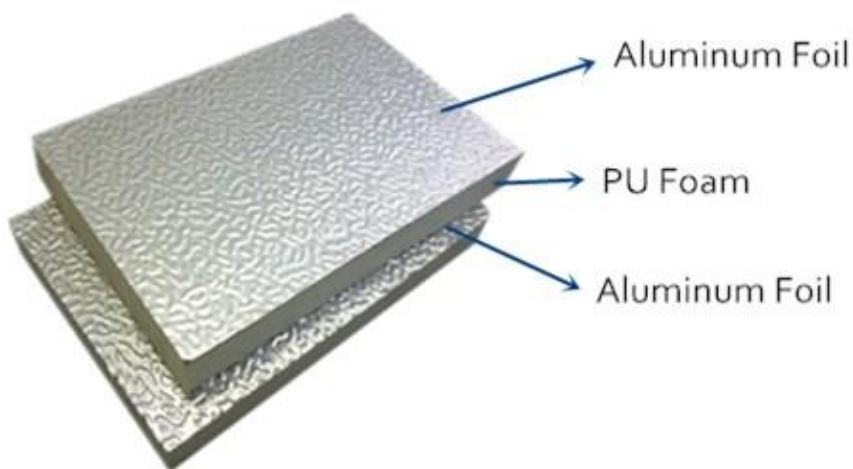

The aluminum foil can be produced in silver, white or black colour, with a smooth or embossed finish. The surface of the panel also can be aluminum sheet, GI or printed color steel, as per the images below:

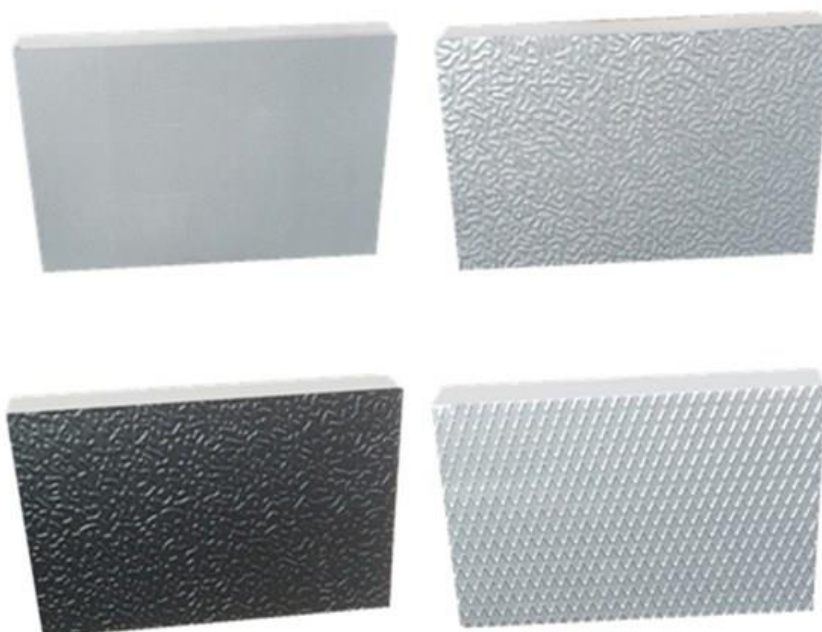

## POLY BOARD SWIRL CUSHION BOX PSW-CB-485-485

### TECHNICAL DATA PU FOAM PRE-INSULATED PANEL (20MM THICK)

PROPERTY	UNIT	SPECIFICATION
Standard Size	mm	3950*1200*20
Foam Density	kg/m <sup>3</sup>	50-55
Aluminium Foil Thickness	micron	80
Aluminium Sheet Thickness	micron	200
Thermal Conductivity	W/m.K	0.02
Thermal Resistance	R-Value	R1.0 (AS/NZS 4859 - ASTM C518 -2017)
Fire Rating	3 Zero	AS/NZS 1530.3-1999
Compressive Strength	Mpa	0.25
Bending Strength	Mpa	2
Water Absorption	%	0.01
Dimension Change	%	0.3
Maximum Wind Velocity	m/s	13-20
Maximum Running Temperature	°C	80

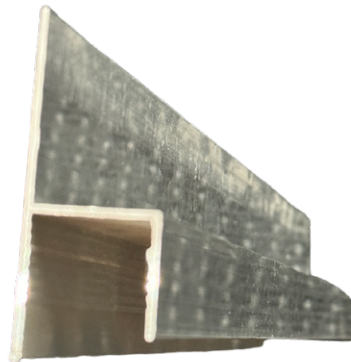

OPTIONAL C-EXTRUSION COVER ATTACHMENT TRIM