

# AIRFOIL

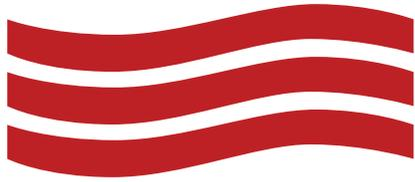

GRILLES  
DUCT  
FITTINGS

*making it happen sooner...*



Quality  
Endorsed  
Company  
ISO 9001  
 SAI GLOBAL

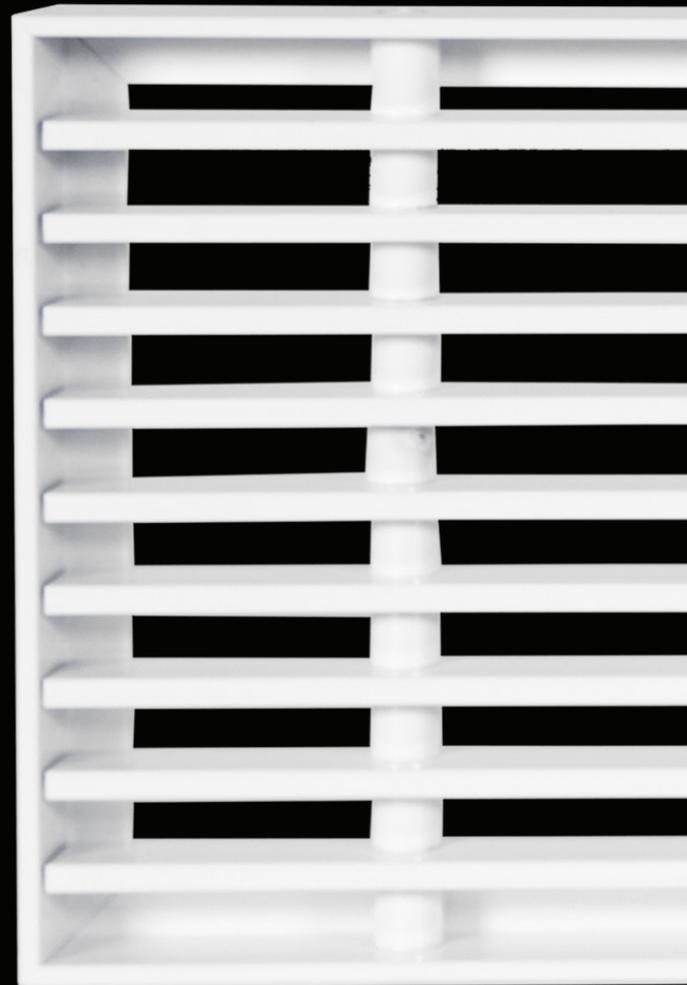

**REVERSE FLANGE  
LINEAR BAR GRILLE  
RFBG-50X25-00**



## REVERSE FLANGE LINEAR BAR GRILLE RFBG-50X25-00

### PRODUCT DESCRIPTION AND APPLICATION

Airfoil's Australian Made and Engineered Reverse Flange Linear Bar Grille RFBG-50x25-00 stands out as a top-of-the-line bar grille option in the market. This custom-made grille is meticulously crafted using high-quality 3mm aluminium extruded profiles, allowing for customisation in size and powder coating in various colours as per requirements. Designed for Supply Air wall-mounting purposes, it is equally versatile for use in Return Air applications, featuring a 50mm Deep Flangeless Frame with a unique 25mm return angle for easy installation.

The key feature of this grille lies in its 20mm x 3mm Flat Bar Blade, arranged at a standard 12mm pitch and supported by a robust round aluminium spaced tube to ensure stability and strength. The aluminium spaced tube is securely attached to the outer frame through an industrial riveting system, enhancing the grille's structural integrity. The Zero Degree Flat Bar Blade design minimises airflow deviation, providing a greater free area for maximising horizontal throw capacity and delivering a well-balanced airflow pattern to designated areas.

The Flangeless Linear Bar Grille RFBG 50x25-00 is a premium product suitable for upscale commercial and residential environments such as apartments, hotels, airports, shopping centres, universities, restaurants, stadiums, and more. Renowned for its exceptional appearance and efficient horizontal air throw performance, this grille is perfect for applications requiring precise air distribution and aesthetic appeal.

## REVERSE FLANGE LINEAR BAR GRILLE RFBG-50X25-00

### PRODUCT SPECIFICATIONS AND INFORMATION

- **Product ordering code – RFBG-50X25-00**
- Australian Made and Designed
- Supply and Return Air application
- Aluminium Construction
- Manufactured to any size
- Flangeless Bar Grille
- 50mm deep frame
- 25mm return leg for installation
- 20mm x 3mm blade
- 0° Flat Bar blade maximising horizontal throw capacity
- 12mm blade spacing as standard (alternate blade spacing available)
- Optional straight cut or fitted ends available
- Blades are held via an aluminium spaced tube supporting mullion
- Wall mounted installation
- Powder-coated standard white or in our Natural Anodised silver finish
- Special powder-coating colours available upon request
- Product suitable for all domestic and commercial settings where the even distribution of air is paramount
- **Deluxe Architectural Range available (visit page 5 to see range)**
- Airfoil tested information available
- **The following metric performance data has been derived from exhaustive testing in elaborate laboratories of acoustic and vibrational engineers Louis A. Challis and Associates Proprietary Limited. Darling Street, Sydney 2000**



## REVERSE FLANGE LINEAR BAR GRILLE RFBG-50X25-00

### CROSS SECTIONAL DIAGRAM

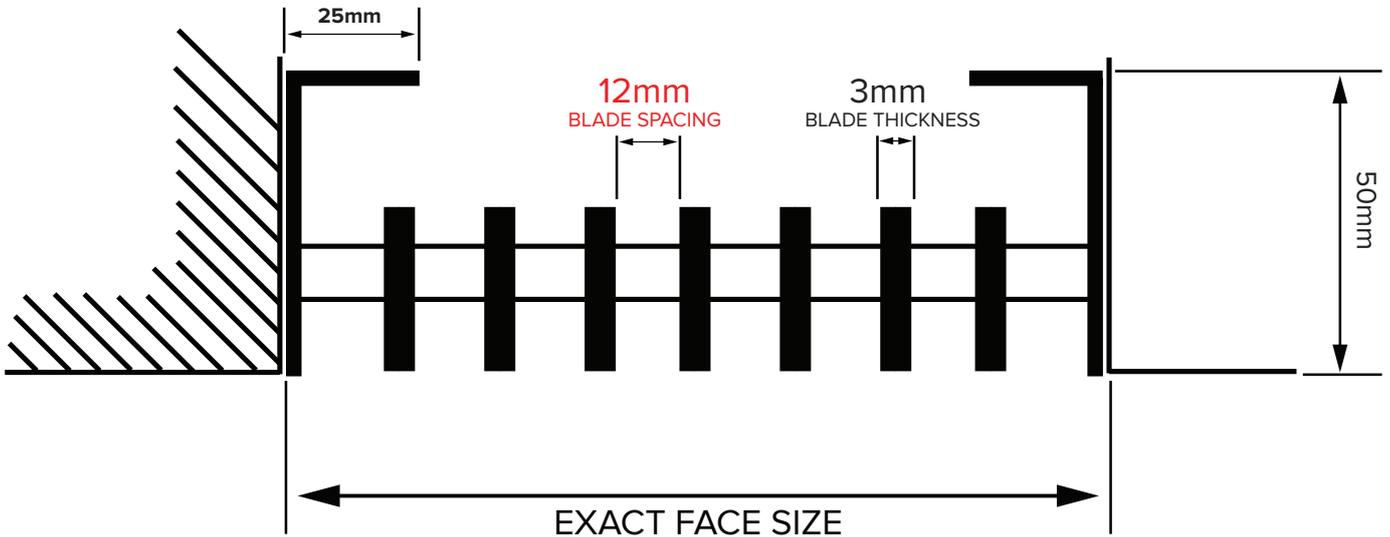

### MITRED 90° OPTIONS

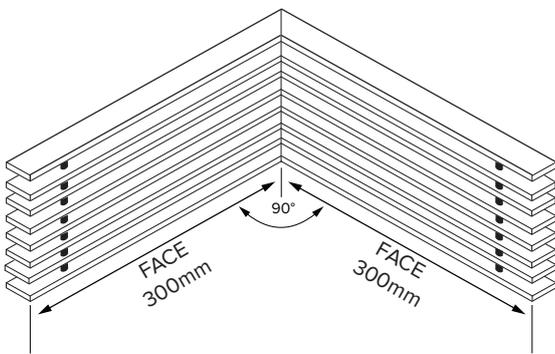

**90° INTERNAL WALL CORNER**

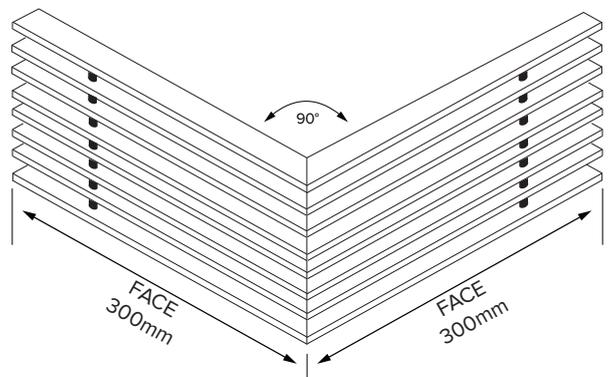

**90° EXTERNAL WALL CORNER**



**DISCLAIMER:**

All product designs, data sheets and specifications presented herein are the intellectual property of Airfoil Manufacturing Pty Ltd. These designs and specifications, including but not limited to diagrams, drawings, and performance data, are protected under Australian intellectual property laws. No part of these designs and specifications may be copied, reproduced, distributed, or transmitted in any form or by any means without the prior written permission of Airfoil Manufacturing Pty Ltd. Unauthorised use or reproduction of these materials may result in legal action under Australian copyright and intellectual property laws.

## REVERSE FLANGE LINEAR BAR GRILLE RFBG-50X25-00

### DELUXE ARCHITECTURAL OPTIONS

Explore Airfoil's Exclusive Australian-Made and Designed "Deluxe Architectural Options", an unparalleled and luxurious addition to our Linear Bar Grille collection. These deluxe features elevate the simple Bar Grille into an architectural masterpiece, setting a new standard in grille manufacturing.

#### OPTION 1 – RFBG-50X25-00 – BLACK SPACERS

Nestled within the core of the Bar Grille are meticulously crafted aluminium spacers, spaced at a 12mm interval. This initial option presents the opportunity for individual aluminium spacers to be powder-coated in Satin Black. Against the backdrop of our White or Natural Anodised Silver bar grille blades, these exquisitely designed black spacers create the illusion that the blades are gracefully suspended within the grille's core.

#### OPTION 2 – RFBG-50X25-00 – BLACK ONE WAY MESH

Furthermore, our Reverse Flange Bar Grille can be fitted with our sumptuous 0.6mm powder-coated Satin Black "Sight Proof One Way Mesh." This premium mesh, meticulously fitted to the rear of the grille, restricts visibility through the bar grille blades, offering both functionality and elegance.

#### OPTION 3 – RFBG-50X25-00 – BLACK SPACERS AND BLACK ONE WAY MESH

For the ultimate refinement, the Reverse Flange Bar Grille can be adorned with "both" our premium Satin Black Spacers and our Satin Black One Way Mesh. The fusion of these deluxe features allows the bar grille blades to command attention, enhancing the illusion of architectural suspension within the grille. This combination epitomises opulence, contemporary design, and exclusivity, making it the premier choice, available exclusively from Airfoil.



12MM FLOATING BLACK SPACERS



BLACK ONE WAY MESH  
23%-36% OPEN AREA

## REVERSE FLANGE LINEAR BAR GRILLE RFBG-50X25-00

DELUXE ARCHITECTURAL OPTIONS – WHITE POWDER COATED

**OPTION 1 – RFBG-50X25-00 – BLACK SPACERS**

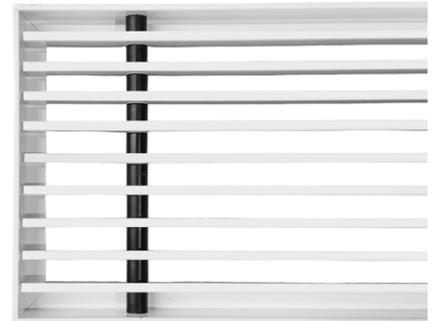

**OPTION 2 – RFBG-50X25-00 – BLACK ONE WAY MESH**

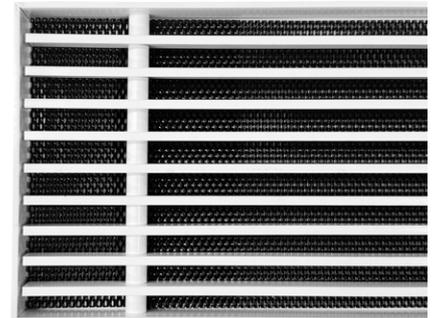
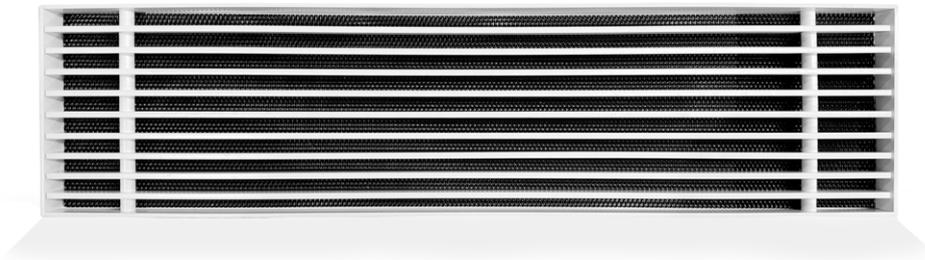

**OPTION 3 – RFBG-50X25-00 – BLACK SPACERS / BLACK ONE WAY MESH**

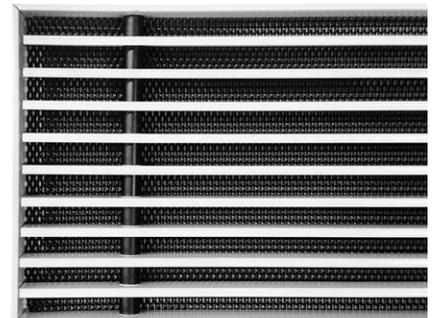
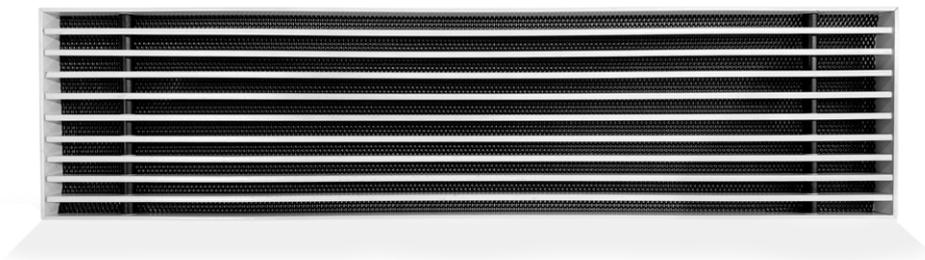

Our Reverse Flange Linear Bar Grilles can be powder coated to any specific colour on request\*

## REVERSE FLANGE LINEAR BAR GRILLE RFBG-50X25-00

### DELUXE ARCHITECTURAL OPTIONS – NATURAL ANODISED

#### OPTION 1 – RFBG-50X25-00 – BLACK SPACERS

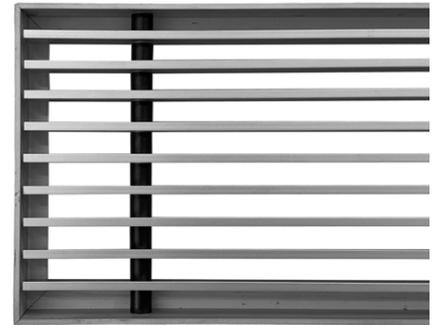
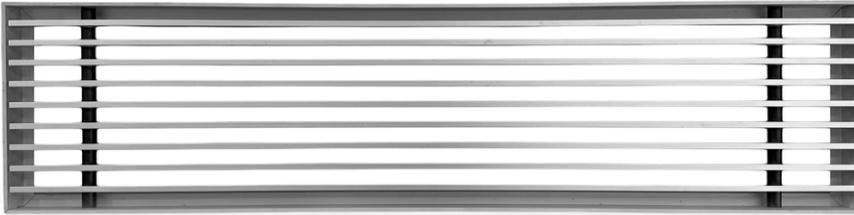

#### OPTION 2 – RFBG-50X25-00 – BLACK ONE WAY MESH

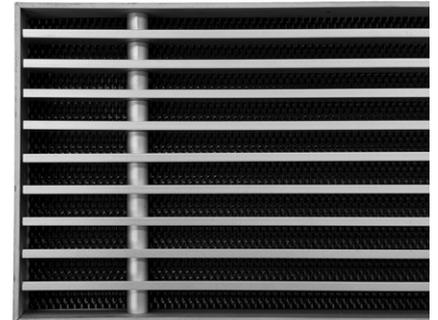
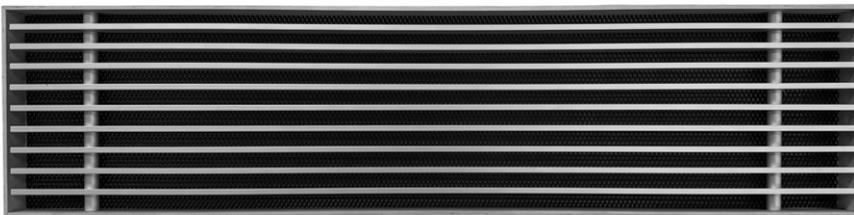

#### OPTION 3 – RFBG-50X25-00 – BLACK SPACERS / BLACK ONE WAY MESH

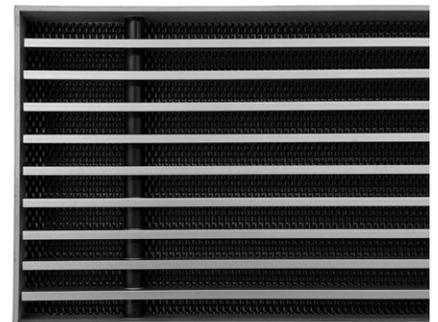
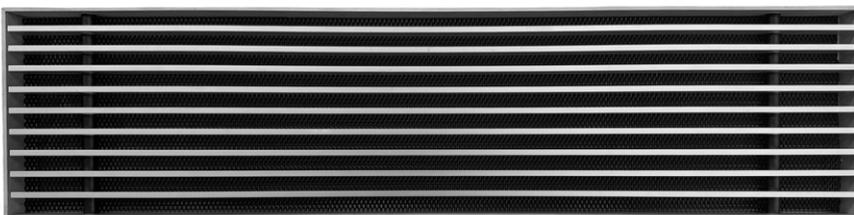

## REVERSE FLANGE LINEAR BAR GRILLE RFBG-50X25-00

### MANUFACTURED OPTIONS

Airfoil's Australian-made and designed Reverse Flange Linear Bar Grille offers versatility with three different manufacturing options, enabling exceptional architectural aesthetics and accommodating various installation requirements due to on-site building restrictions. The Reverse Flange design features create distinct "Shadow Lines," enhancing the bar grille's deluxe and luxurious appearance upon installation. Let's explore the manufacturing options:

#### TYPE 1 – RFBG-50X25-00 – REVERSE ANGLE (LEGS TURNED IN) [STANDARD]

In this standard option, all four Reverse Flange Legs are "Turned In," ensuring a sleek and seamless linear bar grille aesthetic without any visible Shadow Lines upon installation. This represents Airfoil's most popular choice among standard options.

#### TYPE 2 – RFBG-50X25-00 – REVERSE ANGLE (LEGS TURNED OUT)

For those seeking a warmer, opulent architectural look, both the Top and Bottom Reverse Flange Legs are "Turned Out." This configuration allows for a 9mm Shadow Line to emerge at both the top and bottom of the grille, adding depth and character. This style of Bar Grille can be supplied with "Side Ends" for a complete look or with no ends, presenting a raw "Straight Cut" appearance to the bar grille's end blades.

#### TYPE 3 – RFBG-50X25-00 – REVERSE ANGLE (BOTTOM LEG IN / TOP LEG OUT)

In this configuration, the Reverse Flange Bar Grille features the bottom leg "Turned In" while the top leg is "Turned Out." This design choice creates a 9mm Shadow Line specifically at the bottom of the grille. Particularly useful when installed over cupboard areas or building fixtures, this style of Bar Grille is versatile. Similar to Option 2, it can be provided with or without "Side Ends," offering flexibility in achieving the desired aesthetic, whether it's a finished look or a raw, industrial appeal with "Straight-Cut" end blades.

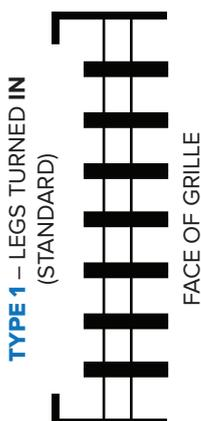

## REVERSE FLANGE LINEAR BAR GRILLE RFBG-50X25-00

### MANUFACTURED OPTIONS

#### TYPE 1 – RFBG-50X25-00 – REVERSE ANGLE (LEGS TURNED IN)

SIDE ENDS (SE)

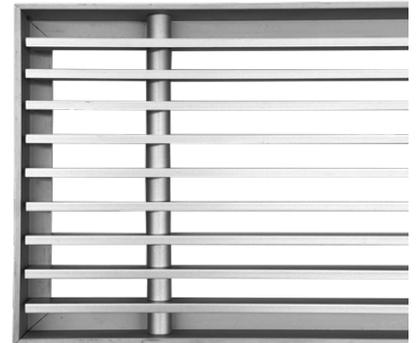

STRAIGHT CUT (SC)

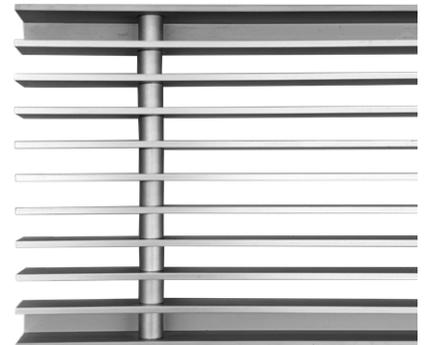

#### TYPE 1 – LEGS TURNED IN (STANDARD)



FACE OF GRILLE

## REVERSE FLANGE LINEAR BAR GRILLE RFBG-50X25-00

### MANUFACTURED OPTIONS

#### TYPE 2 – RFBG-50X25-00 – REVERSE ANGLE (LEGS TURNED OUT)

SIDE ENDS (SE)

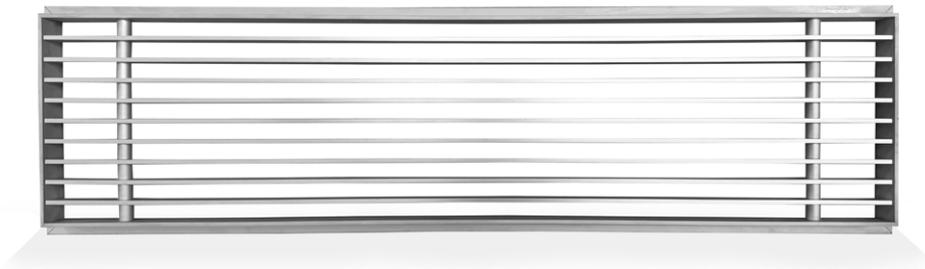

STRAIGHT CUT (SC)

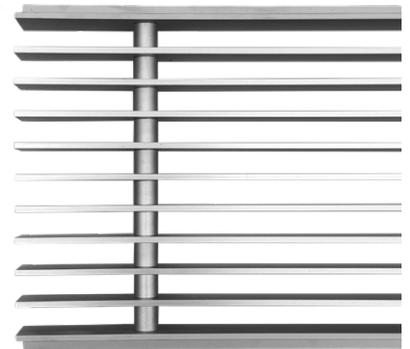
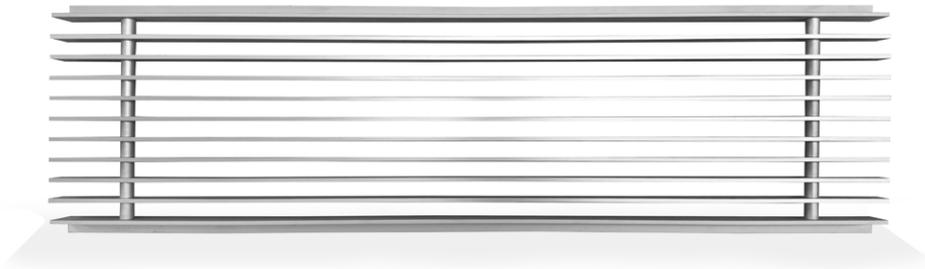

#### TYPE 2 – LEGS TURNED OUT

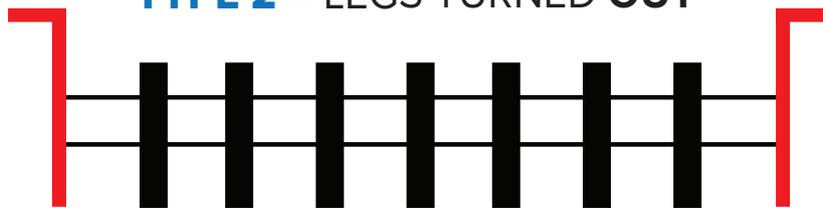

FACE OF GRILLE

## REVERSE FLANGE LINEAR BAR GRILLE RFBG-50X25-00

### MANUFACTURED OPTIONS

**TYPE 3 – RFBG-50X25-00 – REVERSE ANGLE (BOTTOM LEG IN /TOP LEG OUT)**

FLAT BAR END CAP (EC)

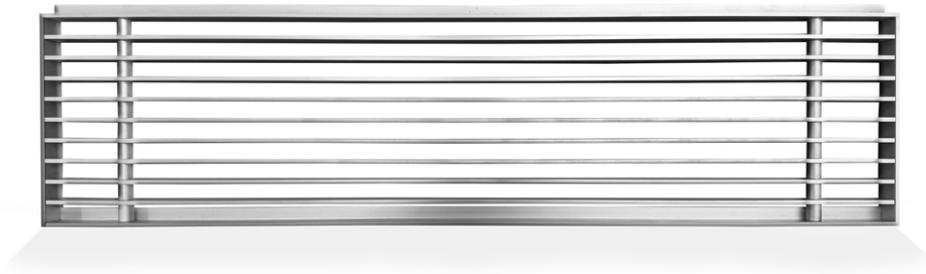

STRAIGHT CUT (SC)

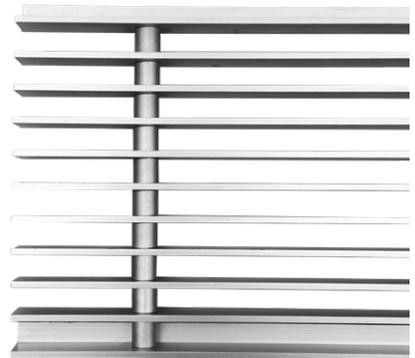
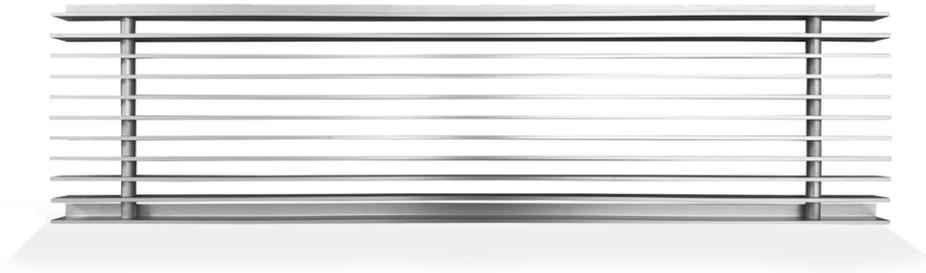

**TYPE 3 – BOTTOM LEG IN  
TOP LEG OUT**



FACE OF GRILLE

## REVERSE FLANGE LINEAR BAR GRILLE RFBG-50X25-00

### PERFORMANCE DATA – SUPPLY AIR

Neck Size	Total Pressure (pa)	3	5	9	14	20	27	36	45
50mm	Lit/sec/metre	34	51	68	85	100	110	130	150
	Throw min/max (m)	1.2-2.4	2.1-4.3	3-5.8	3.9-7.2	4.8-8.4	5.7-9.4	6.3-10.1	6.6-10.8
	Noise Rating NR	-	14	15	21	26	30	34	37
75mm	Lit/sec/metre	58	89	110	140	170	200	230	270
	Throw min/max (m)	2.1-3.6	3.0-5.0	4.5-6.7	5.4-8.4	6.6-9.4	8.1-10.8	9.0-12.2	10.5-13.7
	Noise Rating NR	-	-	14	20	25	29	33	36
100mm	Lit/sec/metre	86	120	170	210	250	300	340	380
	Throw min/max (m)	2.7-3.8	4.5-6.0	5.7-7.7	7.2-9.1	9.0-10.8	9.9-12.2	10.8-13.4	12.6-15.4
	Noise Rating NR	-	-	15	21	26	30	34	37
150mm	Lit/sec/metre	130	210	270	340	410	480	550	620
	Throw min/max (m)	4.3-5.5	6.4-7.3	7.8-8.8	9.8-10.6	11.7-12.5	13.6-14.3	14.7-15	16.6-16.8
	Noise Rating NR	-	-	21	22	27	31	35	38

Sound values are based on a room absorption of 8 dB, re  $10^{-12}$  watts for an active length of **3 metres**.

**Horizontal Throw** distances indicated are terminal velocities of 0.25 and 0.75 metres per second for an active length of **3 metres**. The following corrections for length should be made.

Active length in metres NR	0.3 <i>subtract 9</i>	0.6 <i>subtract 7</i>	1.2 <i>subtract 4</i>	2 <i>subtract 1</i>	3 <i>table value</i>	4 <i>add 1</i>	6 <i>add 3</i>
Throw at term vel. .075	multiply throw by 0.3		multiply throw by 0.7		table values		
Throw at term vel. .025	multiply throw by 0.6		multiply throw by 0.8		table values		

When used as a **Return Air Grille** the following corrections should be made.

1. NR value increases by 4.

2. Negative Static Pressure = Total Pressure (shown in the table) x 0.8

## REVERSE FLANGE LINEAR BAR GRILLE RFBG-50X25-00

### PERFORMANCE DATA – SUPPLY AIR

Neck Size	Total Pressure (pa)	5	10	20	30	40	50	60	70
100mm	Lit/sec/metre	140	210	300	360	415	470	520	565
	Throw (m) 0.25m/s to 0.75m/s	3.3-5.9	4.4-7.2	6.4-9.6	7.8-11.5	9-13.5	10.5-15	12-15.5	13.5-16
	Noise Rating NR	<15	<15	28	32	37	40	44	46
150mm	Lit/sec/metre	230	320	460	575	670	750	820	900
	Throw (m) 0.25m/s to 0.75m/s	4.5-6.5	6-8	8.5-11.5	9.9-13	11-14.5	12-16	13.5-17	15-19
	Noise Rating NR	<15	<15	28	32	38	41	44	48
200mm	Lit/sec/metre	310	400	565	680	785	865	950	1020
	Throw (m) 0.25m/s to 0.75m/s	3.2-6.5	4.7-9.2	6.4-13	8.5-15.5	9-18.5	9.5-19.5	10.5-21	11.5-23
	Noise Rating NR	<15	28	37	40	43	46	47	50
250mm	Lit/sec/metre	425	530	760	920	1035	1150	1270	1400
	Throw (m) 0.25m/s to 0.75m/s	2.9-5.5	4.5-9	6.5-13	8-15.5	10.5-18.5	11-20	12-23	13-25
	Noise Rating NR	21	31	37	40	44	46	48	51
300mm	Lit/sec/metre	505	690	920	1210	1380	1550	1650	1820
	Throw (m) 0.25m/s to 0.75m/s	3.5-6.5	5.2-10	6.8-13.5	8.4-16.5	10.5-21	12-23	13-25	13.5-26
	Noise Rating NR	21	26	36	40	43	46	47	52
400mm	Lit/sec/metre	665	860	1150	1400	1625	1850	2025	2170
	Throw (m) 0.25m/s to 0.75m/s	3.5-6.5	5-10	8-15	9-17	11-21	12-24	13-26	14-28
	Noise Rating NR	21	26	36	40	43	46	47	52

**Horizontal Throw** distances indicated are terminal velocities of 0.25 and 0.75 metres per second for an active length of **1.2 metres**.

For Return or Exhaust air, Pressure drop and Noise levels may be calculated by using the following formula.  
 Static Pressure Drop - Return Air = Static Pressure (Pa) X 1.5 & NR Return Air = NR + 9