



Easy cleaning of sensor tubes



Variant with nozzle and connecting circular spigot



Variant with bluff body and flange

Variable volume flow control - LABCONTROL TVLK



Optimised for use in laboratories and on fume cupboards

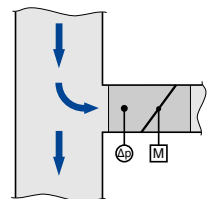

For all upstream conditions

Plastic circular VAV terminal units for aggressive extract air in laboratories and production facilities

- Casing and damper blade made of flame-resistant polypropylene
- Compact construction, only 400 mm long
- High control accuracy even in case of unfavourable upstream conditions
- Combination with fast-running actuators (air management systems)
- Volume flow rate measurement with bluff body or nozzle
- Slide-out sensor tubes allow for easy cleaning
- Closed blade air leakage to EN 1751, class 4
- Casing air leakage to EN 1751, class C



Tested to VDI 6022

Optional equipment and accessories

- With flanges on both ends
- Plastic secondary silencer Type CAK for the reduction of air-regenerated noise

General information	2	Order code	8
Function	3	Variants	10
Technical data	4	Dimensions and weight	12
Quick sizing	4	Product details	15
Specification text	7	Nomenclature	17

General information

Application

- Circular VAV terminal units for use in ventilation and air conditioning systems
- Terminal unit made of plastic for controlling the volume flow rate of fume cupboards and fume hoods in labs
- Suitable for contaminated air
- Closed-loop volume flow control using an external power supply
- For variable and constant volume flows
- Shut-off by means of switching (equipment supplied by others)

Special features

- High control accuracy even in case of unfavourable upstream conditions
- Integral effective pressure sensor with 3 mm measuring holes (resistant to dust and pollution)
- Construction with bluff body: Slide-out sensor tubes allow for easy inspection and cleaning
- No metal parts come into contact with the airflow
- Factory set-up or programming and aerodynamic function testing
- Configuration and subsequent parameter setting for the control component can be done with the EasyConnect configuration software

Nominal sizes

- Bluff body: 250 – 100, 250 – 160
- Nozzle: 250 – D08, 250 – D10, 250 – D16
- Bluff body available in 2 sizes and nozzle available in 3 sizes for various volume flow rate ranges

Variants

- TVLK: VAV terminal unit
- TVLK-FL: VAV terminal unit with flanges on both ends

Parts and characteristics

- Ready-to-commission unit which consists of mechanical parts and control components (attachments)
- Averaging effective pressure sensor for volume flow rate measurement, the construction with bluff body has a slide-out sensor that can be removed for cleaning
- Damper blade
- Factory assembled control components (attachments) complete with wiring and tubing
- Aerodynamic functional testing on a special test rig before shipping of each unit
- Set-up data is given on a label affixed to the unit

Attachments

- LABCONTROL: Control components (attachments) for air management systems

Accessories

- Matching flanges for both ends, including seals

Useful additions

- Plastic secondary silencer Type CAK for demanding acoustic requirements

Construction features

- Circular casing
- Short casing: 392 mm without flange, 400 mm with flange
- Spigot suitable for ducts according to DIN 8077
- Both spigots with the same diameter (250 mm)
- Position of the damper blade indicated externally at shaft extension

Materials and surfaces

- Casing and damper blade made of flame-resistant polypropylene (PP), flammability to UL 94, V-0
- Effective pressure sensor (bluff body or Venturi nozzle) and plain bearings made of polypropylene (PP)
- Damper blade seal made of thermoplastic elastomers (TPE)

Standards and guidelines

Fulfils the hygiene requirements of

- EN 16798, Part 3
- VDI 6022, Sheet 1
- DIN 1946, Part 4
- For other applicable standards and guidelines refer to the hygiene certificate

Casing leakage

- EN 1751, Class C

Closed blade air leakage

- EN 1751, class 4
- Meets the increased requirements of DIN 1946, Part 4, with regard to the acceptable closed blade air leakage

Maintenance

- Maintenance-free as construction and materials are not subject to wear
- We recommend zero point correction once a year; alternatively you can use the EASYLAB control component with the EM-AUTOZERO expansion module for automatic zero point correction

Function

The VAV terminal unit is fitted with an effective pressure sensor with a bluff body or a nozzle for measuring the volume flow rate. The control components (attachments) include an effective pressure transducer that transforms the effective pressure into an electric signal, a controller, and an actuator. The controller compares the actual value with the setpoint value and alters the control signal of the actuator if there is a difference between the two values.

Setpoint value default setting

Fume cupboard control

- The volume flow rate setpoint depends on the control strategy for the fume cupboard:
 - Face velocity
 - Sash distance
 - Combination of face velocity and sash distance
 - Using switch contacts (2-point, 3-point)
 - Constant value

Volume flow control

- The volume flow rate setpoint is specified by an external setpoint value setting

Schematic illustration of the TVLK

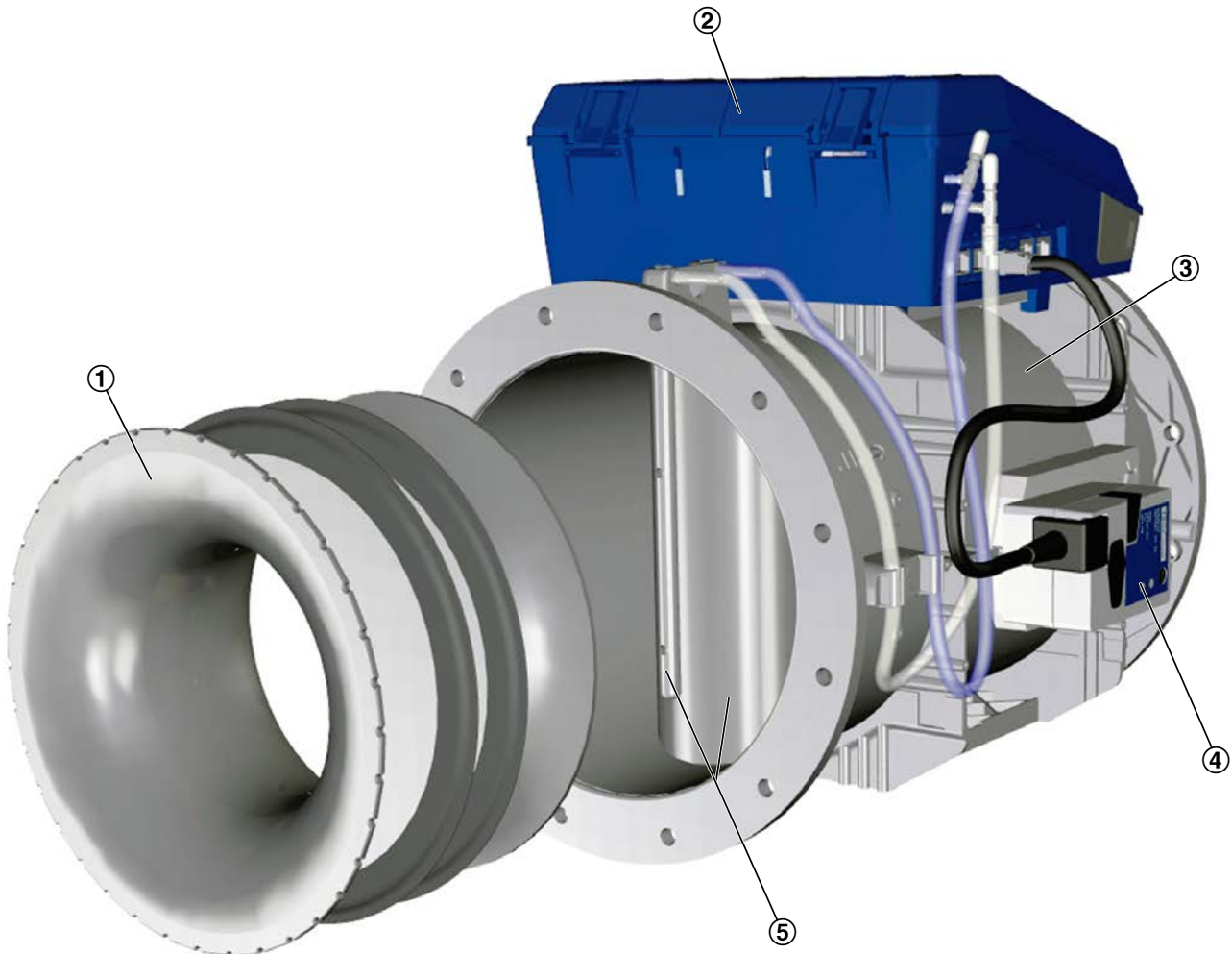

- ① Nozzle (optional)
- ② EASYLAB control component
- ③ Casing
- ④ Actuator
- ⑤ Bluff body and sensor tubes

Technical data

Nominal sizes	250 mm
Volume flow rate range	30 – 515 l/s or 108 – 1854 m ³ /h
Volume flow rate control range	Approx. 15 to 100 % of the nominal volume flow rate
Minimum differential pressure	5 – 130 Pa
Maximum differential pressure	1000 Pa
Operating temperature	10 – 50 °C

Quick sizing

Quick sizing tables provide a good overview of the minimum differential pressures, the volume flow rate accuracy and the room sound pressure levels that can be expected. Intermediate values may be achieved by interpolation.

The sound power levels for calculating the sound pressure levels were measured in the TROX laboratory according to DIN EN ISO 5135 - see "Basic information and nomenclature".

Precise results and spectral data for all control components can be calculated with our Easy Product Finder design program. The first selection criteria for the nominal size are the actual volume flow rates q_{vmin} and q_{vmax} .

Volume flow rate ranges and minimum differential pressure values

The minimum differential pressure of VAV terminal units is an important factor in designing the ductwork and in rating the fan including speed control. It must be ensured that for all operating conditions and for all terminal units a sufficient pressure differential is applied to each controller ($\Delta_{pstat,min}$). The measurement points for fan speed control must be selected accordingly. The volume flow rates given for VAV terminal units depend on the nominal size and on the control component (attachment) that is installed.

Volume flow rate ranges and minimum differential pressure values

Controller for static pressure measurements

Attachment: ELAB

NS	qv [l/s]	qv [m ³ /h]	$\Delta_{pstatmin}$ [Pa]				Δ_{qv} [±%]
			①	②	③	④	
250 - 100	57	202	2	2	2	2	10
250 - 100	172	618	17	18	18	18	7
250 - 100	288	1035	48	49	50	50	5
250 - 100	403	1451	94	95	97	99	5
250 - 160	30	108	3	3	3	3	10
250 - 160	92	330	26	26	26	26	7
250 - 160	153	551	71	71	72	72	6
250 - 160	214	773	139	140	140	141	5
250 - D08	76	273	1	1	1	2	11
250 - D08	233	838	9	9	10	10	7
250 - D08	389	1402	23	25	26	28	6
250 - D08	546	1967	45	48	51	54	5
250 - D10	55	196	2	2	2	2	10
250 - D10	167	601	10	11	11	11	7
250 - D10	279	1006	28	29	29	30	6
250 - D10	391	1411	54	56	57	59	5
250 - D16	31	111	2	2	2	2	10
250 - D16	94	340	15	15	16	16	7
250 - D16	158	569	42	42	43	43	5
250 - D16	221	798	82	83	83	84	5

① Basic unit

② Basic unit with circular silencer CAK, insulation thickness 50 mm, length 500 mm

③ Basic unit with circular silencer CAK, insulation thickness 50 mm, length 1000 mm

④ Basic unit with circular silencer CAK, insulation thickness 50 mm, length 1500 mm

Quick sizing table for sound pressure level

In the quick sizing tables, practical attenuation and insulation values (system attenuation) are included in the tables. If the sound pressure level exceeds the required level, a larger air terminal unit and/or a silencer is required. For more information on the acoustic data, see the basic information and nomenclature.

Quick sizing table for air-regenerated noise L_{PA}

Controller including silencer
(total flow rate range of type)

NS	qv [l/s]	qv [m³/h]	150 Pa				500 Pa			
			①	②	③	④	①	②	③	④
250 - 100	57	202	40	34	30	27	53	47	44	40
250 - 100	172	618	48	41	37	33	60	54	50	47
250 - 100	288	1035	49	41	38	34	62	55	52	48
250 - 100	403	1451	50	42	38	35	63	56	52	49
250 - 160	30	108	40	34	31	28	54	49	46	42
250 - 160	92	330	45	39	35	32	59	54	50	47
250 - 160	153	551	46	40	37	34	61	55	52	49
250 - 160	214	773	47	40	36	33	61	55	52	48
250 - D08	76	273	33	25	21	18	41	33	30	26
250 - D08	233	838	41	33	30	27	49	42	38	35
250 - D08	389	1402	43	36	32	29	51	44	40	37
250 - D08	546	1967	45	37	34	31	53	45	42	39
250 - D10	55	196	38	32	28	25	45	39	35	32
250 - D10	167	601	45	37	34	31	52	45	41	39
250 - D10	279	1006	46	38	35	32	53	46	42	40
250 - D10	391	1411	46	39	35	32	53	46	43	40
250 - D16	31	111	35	30	27	24	47	42	39	36
250 - D16	94	340	43	38	35	32	55	50	47	44
250 - D16	158	569	46	41	38	35	58	53	50	47
250 - D16	221	798	47	41	39	36	59	54	51	48

Air-regenerated noise L_{PA} [dB] at static differential pressure Δ_{pst} of 150 or 500 Pa

- ① Basic unit
- ② Basic unit with circular silencer CAK, insulation thickness 50 mm, length 500 mm
- ③ Basic unit with circular silencer CAK, insulation thickness 50 mm, length 1000 mm
- ④ Basic unit with circular silencer CAK, insulation thickness 50 mm, length 1500 mm

Quick sizing table for case-radiated noise L_{PA}

NS	qv [l/s]	qv [m³/h]	150 Pa	500 Pa
			①	
250 - 100	57	202	27	40
250 - 100	172	618	35	48
250 - 100	288	1035	39	52
250 - 100	403	1451	42	54
250 - 160	30	108	25	39
250 - 160	92	330	30	44
250 - 160	153	551	32	47
250 - 160	214	773	34	48
250 - D08	76	273	21	29
250 - D08	233	838	31	39
250 - D08	389	1402	36	44
250 - D08	546	1967	39	47



NS	qv [l/s]	qv [m³/h]	150 Pa	500 Pa
			①	
250 - D10	55	196	25	32
250 - D10	167	601	32	40
250 - D10	279	1006	36	43
250 - D10	391	1411	38	45
250 - D16	31	111	22	34
250 - D16	94	340	30	42
250 - D16	158	569	34	46
250 - D16	221	798	36	48

Case-radiated noise L_{PA} [dB] at static differential pressure Δ_{pst} of 150 or 500 Pa

n.a.: The specified static differential pressure Δ_{pst} is less than $\Delta_{pst \min}$.

Specification text

This specification text describes the general properties of the product. Texts for variants can be generated with our Easy Product Finder design program.

Specification text

Circular VAV terminal units made of flame-resistant plastic, for variable air volume systems and fume cupboards. Suitable for the control of extract air containing hazardous particles, as all components coming into contact with the airflow are made of plastic (no interior metal parts). Ready-to-commission unit which consists of the mechanical parts and the electronic control components (attachments). Each unit contains an averaging effective pressure sensor with bluff body or a nozzle for volume flow rate measurement, and a damper blade. Factory assembled control components (attachments) complete with wiring and tubing. Effective pressure sensor with 3 mm measuring holes, hence resistant to contamination. Position of the damper blade indicated externally at shaft extension. The damper blade is factory set to open position, which allows a ventilation airflow even without control. Meets the hygiene requirements of EN 16798, Part 3, of VDI 6022, Sheet 1, and of DIN 1946, Part 4.

Special features

- High control accuracy even in case of unfavourable upstream conditions
- Integral effective pressure sensor with 3 mm measuring holes (resistant to dust and pollution)
- Construction with bluff body: Slide-out sensor tubes allow for easy inspection and cleaning
- No metal parts come into contact with the airflow
- Factory set-up or programming and aerodynamic function testing
- Configuration and subsequent parameter setting for the control component can be done with the EasyConnect configuration software

Materials and surfaces

- Casing and damper blade made of flame-resistant polypropylene (PP), flammability to UL 94, V-0

- Effective pressure sensor (bluff body or Venturi nozzle) and plain bearings made of polypropylene (PP)
- Damper blade seal made of thermoplastic elastomers (TPE)

Technical data

- Nominal sizes: 250 mm
- Volume flow rate range: 30 – 546 l/s or 108 – 1967 m³/h
- Volume flow rate control range: approx. 15 – 100 % of the nominal volume flow rate
- Minimum differential pressure: Up to 139 Pa (without circular silencer)
- Maximum differential pressure: 1000 Pa
- Closed blade air leakage to EN 1751, class 4
- Casing air leakage to EN 1751, class C

Specification text for attachment

Variable volume flow control with an electronic EASYLAB controller for fume cupboards

- Supply voltage 24 V AC/DC
- Fast and stable control
- Static effective pressure measurement
- Fast-running actuator
- Easy commissioning due to plug and play communication system
- Controller is a modular system and can be expanded
- Volume flow rate monitoring

Sizing data

- q_v _____ [m³/h]
- Δ_{pst} _____ [Pa]

Air-regenerated noise

- L_{PA} _____ [dB(A)]

Case-radiated noise

- L_{PA} _____ [dB(A)]

Order code

Order code for fume cupboard control (with EASYLAB attachment)

TVLK – FL / 250 – 100 / GK / ELAB / S / FH – VS / UMZS / 200 – 900 [m³/h]
 | | | | | | | | |
 1 2 3 4 5 6 7 8 9

1 Type

TVLK VAV terminal unit, plastic

Without signalling

FH-F Volume flow rate constant value control

2 Duct connection

No entry: Spigot

FL Flanges on both ends

8 Expansion modules

Option 1: Supply voltage

No entry: 24 V AC/DC

T EM-TRF for 230 V AC

U EM-TRF-USV for 230 V AC, provides uninterruptible power supply (UPS)

3 Nominal size

250 – 100 Bluff body 100

250 – 160 Bluff body 160

250 – D08 Nozzle D08

250 – D10 Nozzle D10

250 – D16 Nozzle D16

Option 2: Digital communication interface

No entry: None

B EM-BAC-MOD-01 for BACnet MS/TP

M EM-BAC-MOD-01 for Modbus RTU

I EM-IP for BACnet/IP, Modbus/IP and web server

R EM-IP with real time clock

4 Accessories

No entry: None

GK Matching flanges for both ends

5 Attachments (control component)

ELAB EASYLAB controller TCU3

Option 3: Automatic zero point correction

No entry: None

Z EM-AUTOZERO Solenoid valve for automatic zero point correction

6 Actuators

S Fast-running actuator (3 s)

SD Fast-running actuator (3 s), with digital communication interface (TROX HPD)

Option 4: Lighting

No entry: None

S EM-LIGHT Wired socket for the connection of lighting and for switching the lighting on/off using the control panel (only with EM-TRF or EM-TRF-USV)

7 Equipment function

Fume cupboard control

With face velocity transducer

FH-VS Face velocity control strategy

With face velocity transducer and sash distance sensor

FH-VD Optimised face velocity control strategy

9 Operating values [m³/h or l/s]

Depending on the equipment function

FH-VS: $q_{vmin} - q_{vmax}$

FH-VD: $q_{vmin} - q_{vmax}$

FH-DS: $q_{vmin} - q_{vmax}$

FH-DV: $q_{vmin} - q_{vmax}$

FH-2P: q_{v1}/q_{v2}

FH-3P: $q_{v1}/q_{v2}/q_{v3}$

FH-F: q_{v1}

With sash distance sensor

FH-DS Linear control strategy

FH-DV Safety-optimised control strategy

With switch contacts (by others) for switching steps

FH-2P 2 switching steps

FH-3P 3 switching steps

Useful additions

Control panel for fume cupboard controllers, for displaying the functions of the control system according to EN 14175

BE-SEG-02 OLED display

BE-LCD 40-character display

Order example: TVLK-FL/250-100/GK/ELAB/S/FH-VS/200-900 m³/h

Duct connection

With flange

Nominal size

250 with bluff body 100

Accessories

Matching flanges for both ends

Attachments (control component)

EASYLAB controller with fast-running actuator

Actuator

Fast-running actuator (3 s)

Equipment function

Fume cupboard control with face velocity transducer

Volume flow rate

$q_{vmin} = 200 \text{ m}^3/\text{h}$

$q_{vmax} = 900 \text{ m}^3/\text{h}$

Order code for single operation (with EASYLAB attachment)

TVLK – FL / 250 – 100 / GK / ELAB / S / EC – E0 / UMZ / ... [m³/h]
 | | | | | | | | | |
 1 2 3 4 5 6 7 8 9 10

1 Type

TVLK VAV terminal unit, plastic

2 Duct connection

No entry: Spigot

FL Flanges on both ends

3 Nominal size

250 – 100 Bluff body 100

250 – 160 Bluff body 160

250 – D08 Nozzle D08

250 – D10 Nozzle D10

250 – D16 Nozzle D16

4 Accessories

No entry: None

GK Matching flanges for both ends

5 Attachments (control component)

ELAB EASYLAB controller TCU3

6 Actuators

S Fast-running actuator (3 s)

SD Fast-running actuator (3 s), with digital communication interface (TROX HPD)

7 Equipment function

Single operation

EC Extract air controller

8 External volume flow rate setting

Depending on external volume flow rate setting

Order example: TVLK/250–D08/ELAB/S/E2/400–1600 m³/h

Duct connection

Nominal size

Attachments (control component)

Actuator

external volume flow rate setting

Operating values

E0 Voltage signal 0 – 10 V DC

E2 Voltage signal 2 – 10 V DC

2P Switch contacts (provided by others) for 2 switching steps

3P Switch contacts (provided by others) for 3 switching steps

F Volume flow rate constant value, without signalling

9 Expansion modules

Option 1: Supply voltage

No entry: 24 V AC/DC

T EM-TRF for 230 V AC

U EM-TRF-USV for 230 V AC, provides uninterruptible power supply (UPS)

Option 2: Digital communication interface

No entry: None

B EM-BAC-MOD-01 for BACnet MS/TP

M EM-BAC-MOD-01 for Modbus RTU

I EM-IP for BACnet/IP, Modbus/IP and web server

R EM-IP with real time clock

Option 3: Automatic zero point correction

No entry: None

Z EM-AUTOZERO Solenoid valve for automatic zero point correction

10 Operating values [m³/h or l/s]

Depending on external volume flow rate setting:

E0, E2: q_{vmin}/q_{vmax}

2P: q_{v1}/q_{v2}

3P: $q_{v1}/q_{v2}/q_{v3}$

F: q_{v1}

Spigot

250 with nozzle D08

EASYLAB controller TCU3

Fast-running actuator (3 s)

Voltage signal 2 – 10 V DC

$q_{vmin} = 400 \text{ m}^3/\text{h}$

$q_{vmax} = 1600 \text{ m}^3/\text{h}$

Variants

VAV terminal unit TVLK with bluff body and connecting circular spigot



VAV terminal unit TVLK with nozzle and connecting circular spigot



- VAV terminal unit for variable volume flow control
- Spigot

VAV terminal unit TVLK with bluff body and flange



VAV terminal unit TVLK with nozzle and flange



- VAV terminal unit for variable volume flow control
- With flanges to make detachable connections to the ductwork

Material

Standard construction

Order code detail	Part	Material
-	Casing	Plastic, polypropylene (PPs), flame resistant
	Effective pressure sensor	
	Damper blade	
	Damper blade seal	Thermoplastic elastomer (TPE)
	Shaft	Galvanised steel
	Plain bearings	Plastic, polypropylene (PPs), flame resistant

Optional flange

Order code detail	Part	Material
FL	Flange	Plastic, polypropylene (PPs), flame resistant

Optional matching flange

Order code detail	Part	Material
GK	Matching flange	Plastic, polypropylene (PPs), flame resistant
	Seal	Rubber, EPDM

Dimensions and weight

VAV terminal unit (TVLK)

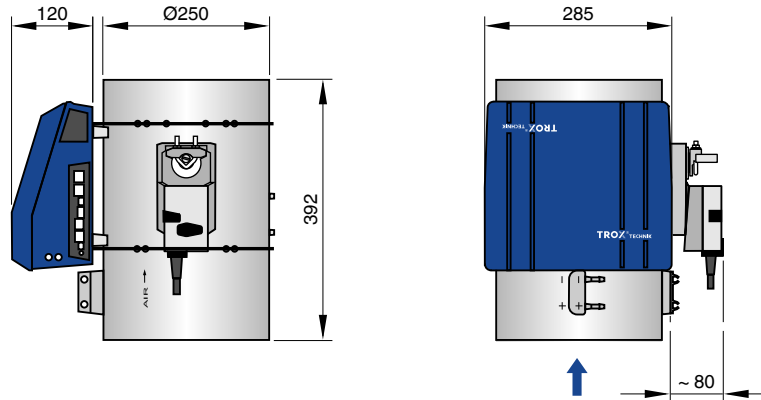

Note:

For exact dimensions of the space required for accessing the control component, see section *Space required for commissioning and maintenance*

Dimensions/weight of TVLK

NS	kg
250	5.1

Terminal unit with flange (TVLK-FL)

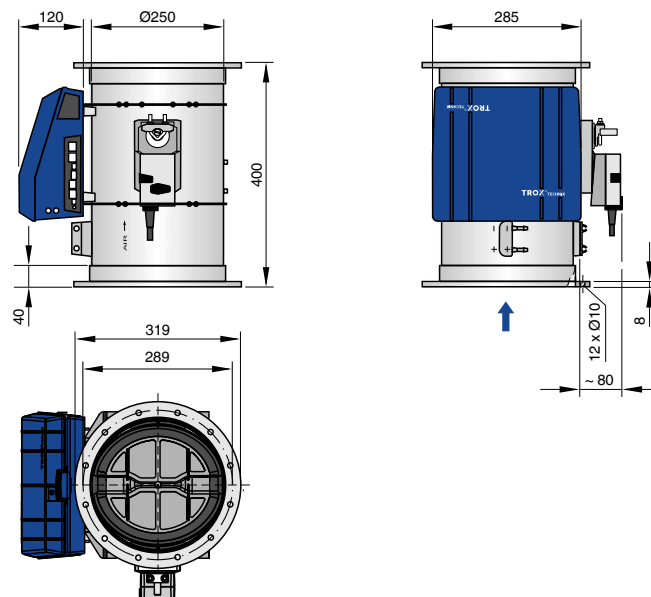

Note:

For exact dimensions of the space required for accessing the control component, see section *Space required for commissioning and maintenance*

Dimensions/weights of TVLK-FL

NS	kg
250	5.7

Space required for commissioning and maintenance

Sufficient space must be kept clear near any attachments to allow for commissioning and maintenance. It may be necessary to provide sufficiently sized inspection access openings. Product illustrations do not show any installation situation details. If an attachment requires a certain installation orientation, this is specified on a sticker on the product.

Access to attachments

Product example

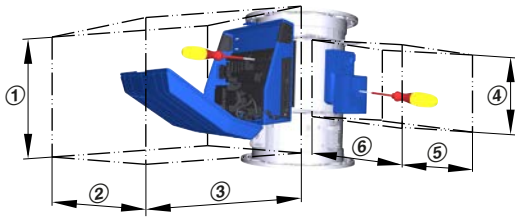

Schematic illustration of required installation space

Attachment ELAB

Space requirement, control components on two sides

Attachment	①	②	③	④	⑤	⑥
LABCONTROL						
EASYLAB: ELAB	350	350	400	300	250	300

Access to sensor tubes for cleaning

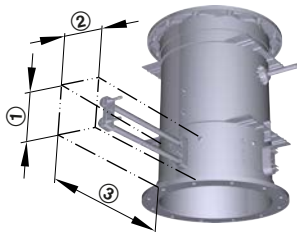

Space required for cleaning the sensor tubes

Nominal size	①	②	③
250-* bluff body	100	160	D ***
250-** nozzle	100	160	100

* Available bluff body sizes: 100 mm, 160 mm

** Available Venturi nozzle sizes: D08, D10, D16

*** D: Casing diameter

Accessibility to the battery pack

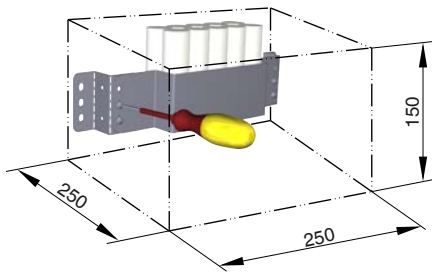

Product illustration

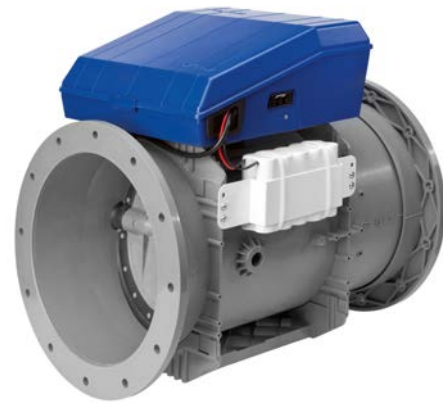

Schematic illustration of required installation space

TVLK/.../ELAB/.../T/

Note: Separate installation space for fixing and accessing the battery pack (optional accessories for TROX UNIVERSAL or LABCONTROL EASYLAB control components).

Product details

Installation orientation

- VAV terminal unit TVLK is made of plastic and intended for aggressive media
- The control component has an integral static pressure transducer
- Installation orientation must be as shown on the sticker

Commissioning

- We recommend zero point correction once a year; alternatively you can use the EASYLAB control component with the EM-AUTOZERO expansion module for automatic zero point correction.

Upstream conditions

The volume flow rate accuracy Δ_{qv} applies to a straight upstream section of the duct. Bends, junctions or a narrowing or widening of the duct cause turbulence that may affect measurement. Duct connections, e.g. branches off the main duct, must comply with EN 1505.

Bend

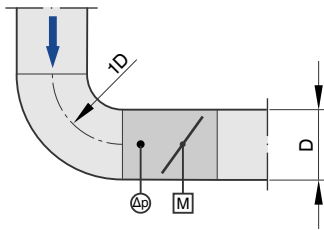

A bend with a centre line curvature radius of at least 1D – without an additional straight duct section upstream of the VAV terminal unit – has only a negligible effect on the volume flow rate accuracy.

Junction

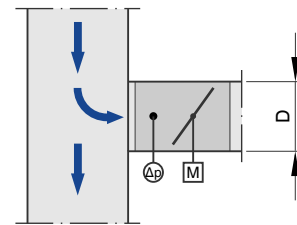

The stated volume flow rate accuracy Δ_{qv} will be achieved even when the VAV terminal unit is installed in a branch just off the main duct. Even the installation on the dome of a fume cupboard will have no adverse effect.

LABCONTROL EASYLAB control components

Attachment	Controlled variable	Interface	Effective pressure transducer	Actuator	Manufacturer
EASYLAB					
ELAB	qv, Δp *	TROX Plug&Play communication system and 0 - 10 V or 2 - 10 V or with optional accessories: Modbus, BACnet, web server	qv = integral Δp = separate	fast-running, separate or fast-running with digital communication interface (TROX HPD), separate	③

① TROX

* The controlled variable depends on the type of VAV terminal unit

- TVR, TVRK: Fume cupboard, room supply air, room extract air, room pressure, single controller
- TVLK: Fume cupboard, single controller
- TVJ, TVT: Room supply air, room extract air, room pressure, single controller
- TVZ, TZ-Silenzio: Room supply air, room pressure, single controller
- TVA, TA-Silenzio: Room extract air, room pressure, single controller

Nomenclature

Dimensions of rectangular units

B [mm]
Duct width

B_1 [mm]
Screw hole pitch of flange (horizontal)

B_2 [mm]
Overall dimension of flange (width)

H [mm]
Duct height

H_1 [mm]
Screw hole pitch of flange (vertical)

H_2 [mm]
Overall dimension of flange (height)

Dimensions of circular units

$\varnothing D$ [mm]
Basic units made of sheet steel: Outer diameter of the spigot;
basic units made of plastic: Inside diameter of the spigot

$\varnothing D_1$ [mm]
Pitch circle diameter of flanges

$\varnothing D_2$ [mm]
Outer diameter of flanges

L [mm]
Length of unit including connecting spigot

L_1 [mm]
Length of casing or acoustic cladding

n []
Number of flange screw holes

T [mm]
Flange thickness

General information

m [kg]
Unit weight including the minimum required attachments (control component)

NS [mm]
Nominal size

f_m [Hz]
Octave band centre frequency

L_{PA} [dB(A)]
A-weighted sound pressure level of air-regenerated noise of the VAV terminal unit, system attenuation taken into account

L_{PA1} [dB(A)]

A-weighted sound pressure level of air-regenerated noise of the VAV terminal unit with secondary silencer, system attenuation taken into account

L_{PA2} [dB(A)]
A-weighted sound pressure level of case-regenerated noise of the VAV terminal unit, system attenuation taken into account

L_{PA3} [dB(A)]
A-weighted sound pressure level of case-regenerated noise of the VAV terminal unit with acoustic cladding, system attenuation taken into account

Note on acoustic data: All sound pressure levels are based on a reference value of 20 μ Pa.

q_{vNom} [m^3/h]; [l/s]
Nominal flow rate (100 %): The value depends on product type, nominal size and control component (attachment). Values are published on the internet and in technical leaflets and stored in the Easy Product Finder design program. Reference value for calculating percentages (e.g. q_{vmax}). Upper limit of the setting range and maximum volume flow rate setpoint value for the VAV terminal unit.

$q_{vmin Unit}$ [m^3/h]; [l/s]
Technically possible minimum volume flow rate: The value depends on product type, nominal size and control component (attachment). Values are stored in the Easy Product Finder design program. Lower limit of the setting range and minimum volume flow rate setpoint value for the VAV terminal unit. Setpoint values below $q_{vmin unit}$ (if q_{vmin} equals zero) may result in unstable control or shut-off.

q_{vmax} [m^3/h]; [l/s]
Upper limit of the operating range for the VAV terminal unit that can be set by customers: q_{vmax} can be set to less than or equal to q_{vNom} . In case of analogue signalling to volume flow controllers (which are typically used), the set maximum value (q_{vmax}) is allocated to the maximum setpoint signal (10 V) (see characteristic).

q_{vmin} [m^3/h]; [l/s]
Lower limit of the operating range for the VAV terminal unit that can be set by customers: q_{vmin} should be set to less than or equal to q_{vmax} . Do not set q_{vmin} to less than $q_{vmin unit}$ as the control may become unstable or the damper blade may close. q_{vmin} may equal zero. In case of analogue signalling to volume flow controllers (which are typically used), the set minimum value (q_{vmin}) is allocated to the minimum setpoint signal (0 or 2 V) (see characteristic).

q_v [m^3/h]; [l/s]
Volume flow rate

Δ_{qv} [%]
Volume flow rate accuracy in relation to the setpoint (tolerance)

Δ_{pst} [Pa]

Static differential pressure

 $\Delta_{pst\ min}$ [Pa]

Static minimum differential pressure: The static minimum differential pressure is equal to the pressure loss of the VAV terminal unit when the damper blade is open, caused by flow resistance (damper blade). If the differential pressure on the VAV terminal unit is too low, the setpoint volume flow rate may not be achieved, not even when the damper blade is open. Important factor in designing the ductwork and in rating the fan including speed control. Sufficient static differential pressure must be ensured for all operating conditions and for all controllers, and the measurement point or points for speed control must have been selected accordingly to achieve this.

Lengths

All lengths are given in millimetres [mm] unless stated otherwise.

Basic unit

Unit for controlling a volume flow without an attached control component. The main components include the casing with sensor(s) to measure the effective pressure and the damper

blade to restrict the volume flow. The basic unit is also referred to as a VAV terminal unit. Important distinguishing features: Geometry or unit shape, material and types of connection, acoustic characteristics (e.g. acoustic cladding or integral sound attenuator), volume flow rate range.

Control component

Electronic unit(s) mounted on the basic unit to control the volume flow rate or the duct pressure or the room pressure by adjusting the damper blade position. The electronic unit consists basically of a controller with effective pressure transducer (integral or external) and an integral actuator (Easy and Compact controllers) or external actuator (Universal or LABCONTROL controllers). Important distinguishing features: Transducer: dynamic transducer for clean air or static transducer for contaminated air. Actuator: slow-running actuator as standard, spring return actuator for safe position, or fast-running actuator. Interface: analogue interface or digital bus interface for the capturing of signals and data.

VAV terminal unit

Consists of a basic unit with an attached control component.